



TM.ONTEC R M1 180 NM ST

TM-OR.M1STN800W



PARAMETERS

Warranty	24 months - ST 36 months - AT 60 months - DATA, CB
Application	anti-panic lighting
IP	IP20
IK	IK03
Version	ST – for button test
Power supply	210÷250 V AC 50÷60 Hz
Power supply CB	186÷254 V DC
Temperature range	10-35 °C
Material	PC
Colour	RAL9003
Duration time	3 h
Operating mode	NM
Maximum light power (the luminaire can power the light source with a different power)	2 W
Active power	1.2 W
Insulation class	2
Luminous flux	158 lm
Battery	LiFePO4/C 3.2V 1.5Ah

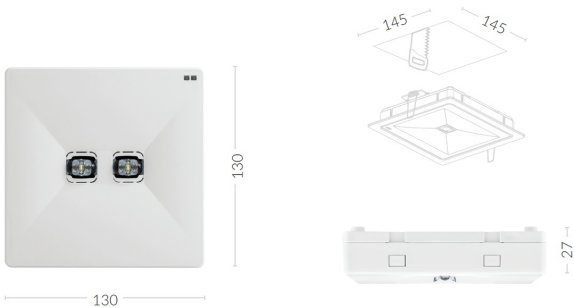



TM.ONTEC R M2 302 M ST

TM-OR.M2STM300W

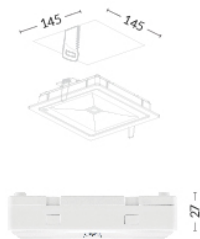
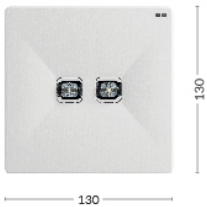

PARAMETERS

Warranty	24 months - ST 36 months - AT 60 months - DATA, CB
Application	anti-panic lighting
IP	IP20
IK	IK03
Version	ST – for button test
Power supply	210+250 V AC 50+60 Hz
Power supply CB	186+254 V DC
Temperature range	10-35 °C
Material	PC
Colour	RAL9003
Duration time	3 h
Operating mode	M
Maximum light power (the luminaire can power the light source with a different power)	2 W
Active power	7.2 W
Insulation class	2
Luminous flux	288 lm
Battery	LiFePO4/C 6.4V 1.5Ah



PHOTOMETRY [m]

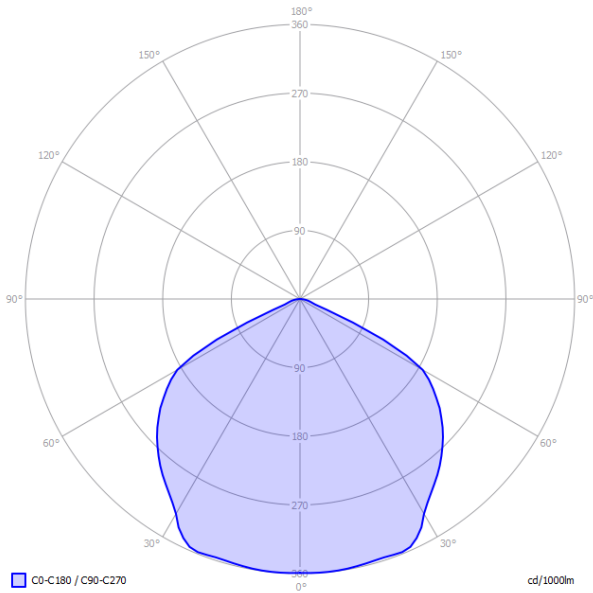

Ceiling height

2,5
3,0
4,0
5,0
6,0
7,0
8,0
9,0
10,0

Distance wall - fitting

3,8
4,3
4,9
5,1
5,2
5,3
5,2
5,0
4,9

Distance fitting - fitting

8,3
9,4
11,6
13,3
14,5
15,8
16,0
16,4
16,6





TM.ONTEC R C1 180 NM ST

TM-OR.C1STN800W

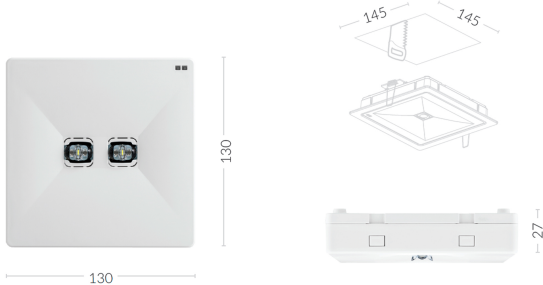

PARAMETERS

Standards	PN-EN 60598-1, PN-EN 60598-2-22, PN-EN 61347-1, PN-EN 61347-2-7, PN-EN 61347-2-13, PN-EN 55015, PN-EN 61000-3-2, PN-EN 62031, PN-EN 62471, PN-EN 1838
Warranty	24 months - AT 36 months - ST 60 months - DATA, CB
Application	escape route lighting
IP	IP20
IK	IK03
Version	ST – for button test
Power supply	210+250 V AC 50+60 Hz
Power supply CB	186+254 V DC
Temperature range	10-35 °C
Material	PC
Colour	RAL9003
Duration time	3 h
Operating mode	NM
Maximum light power (the luminaire can power the light source with a different power)	2 W
Active power	1.2 W
Insulation class	2
Luminous flux	137 lm
Battery	LiFePO4/C 3.2V 1.5Ah



PHOTOMETRY [m]

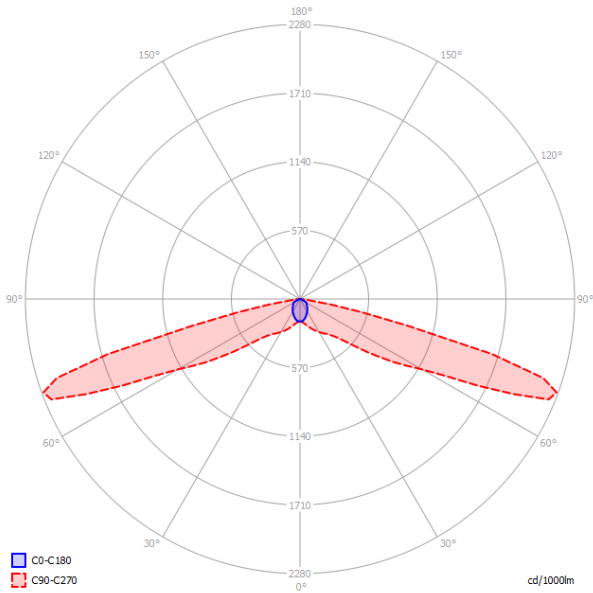

Ceiling height

2,5
3,0
4,0
5,0
6,0
7,0
8,0
9,0
10,0

Distance wall - fitting

8,7
9,8
11,4
12,0
4,9
3,6
3,2

Distance fitting - fitting

19,4
22,2
26,7
30,5
28,7
22,4
18,6





TM.ONTEC R C1 302 M ST

TM-OR.C1STM300W



PARAMETERS

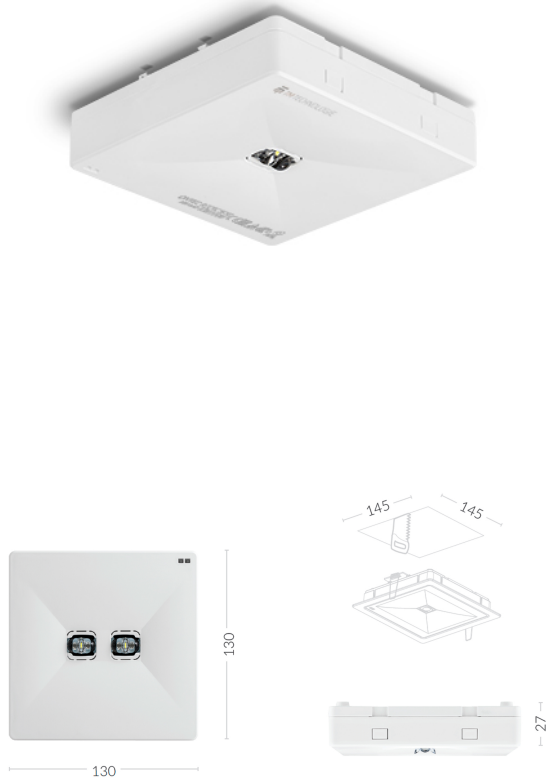

Standards	PN-EN 60598-1, PN-EN 60598-2-22, PN-EN 61347-1, PN-EN 61347-2-7, PN-EN 61347-2-13, PN-EN 55015, PN-EN 61000-3-2, PN-EN 62031, PN-EN 62471, PN-EN 1838
Warranty	24 months - AT 36 months - ST 60 months - DATA, CB
Application	escape route lighting
IP	IP20
IK	IK03
Version	ST – for button test
Power supply	210+250 V AC 50+60 Hz
Power supply CB	186+254 V DC
Temperature range	10-35 °C
Material	PC
Colour	RAL9003
Duration time	3 h
Operating mode	M
Maximum light power (the luminaire can power the light source with a different power)	2 W
Active power	7.2 W
Insulation class	2
Luminous flux	246 lm
Battery	LiFePO4/C 6.4V 1.5Ah



PHOTOMETRY [m]

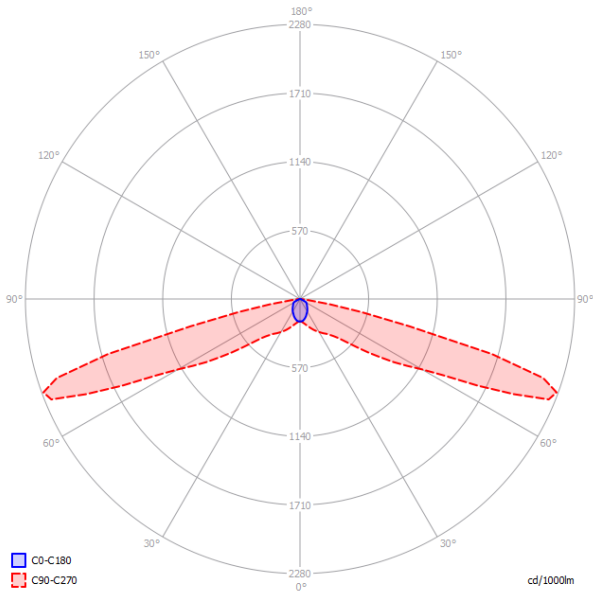

Ceiling height

2,5
3,0
4,0
5,0
6,0
7,0
8,0
9,0
10,0

Distance wall - fitting

8,7
9,8
11,4
12,0
4,9
3,6
3,2

Distance fitting - fitting

19,4
22,2
26,7
30,5
28,7
22,4
18,6





TM.ONTEC R W1 180 NM ST

TM-OR.W1STN800W

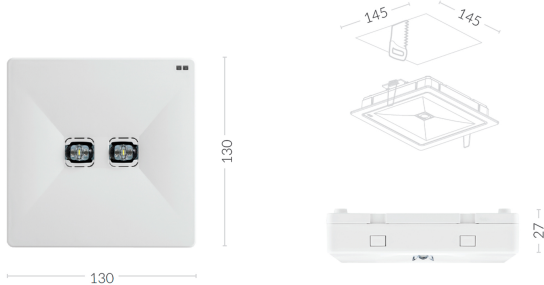

PARAMETERS

Standards	PN-EN 60598-1, PN-EN 60598-2-22, PN-EN 61347-1, PN-EN 61347-2-7, PN-EN 61347-2-13, PN-EN 55015, PN-EN 61000-3-2, PN-EN 62031, PN-EN 62471, PN-EN 1838
Warranty	24 months - ST 36 months - AT 60 months - DATA, CB
Application	lighting of the final exit / fire-protection devices
IP	IP20
IK	IK03
Version	ST – for button test
Power supply	210+250 V AC 50+60 Hz
Power supply CB	186+254 V DC
Temperature range	10-35 °C
Material	PC
Colour	RAL9003
Duration time	3 h
Operating mode	NM
Maximum light power (the luminaire can power the light source with a different power)	2 W
Active power	1.2 W
Insulation class	2
Luminous flux	139 lm
Battery	LiFePO4/C 3.2V 1.5Ah



PHOTOMETRY [m]

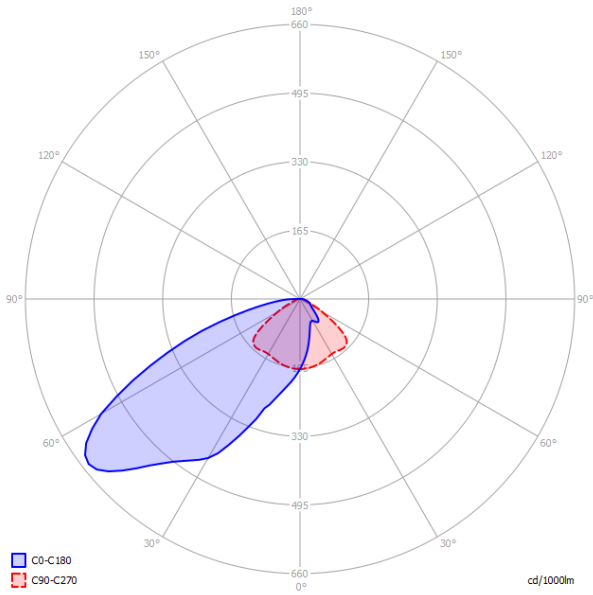

Ceiling height

2,5
3,0
4,0
5,0
6,0
7,0
8,0
9,0
10,0

Distance wall - fitting

3,2
3,4
3,5
3,4

Distance fitting - fitting

7,6
8,1
8,3
8,7





TM.ONTEC R M5 305 M DALI

TM-OR.M5.DA002



PARAMETERS

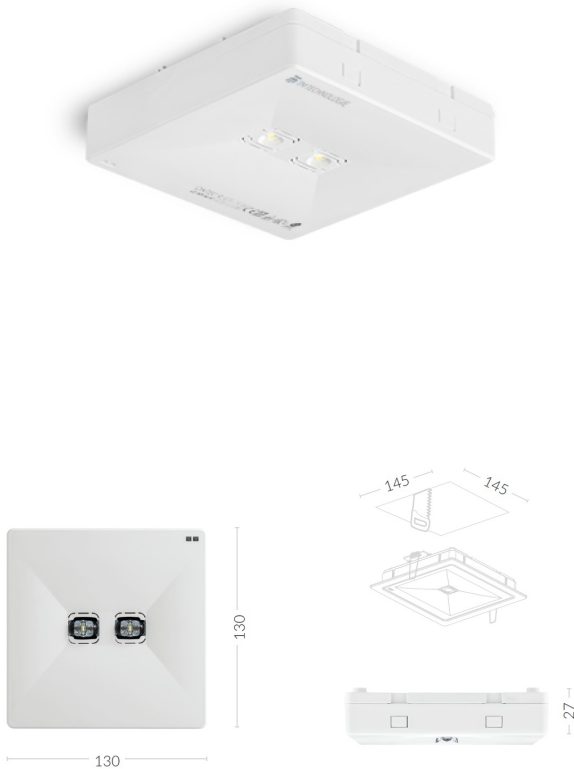

Warranty	24 months - ST 36 months - AT 60 months - DATA, CB
Application	anti-panic lighting
IP	IP20
IK	IK03
Version	DALI
Power supply	210+250 V AC 50+60 Hz
Power supply CB	186+254 V DC
Temperature range	10-35 °C
Material	PC
Colour	RAL9003
Duration time	3 h
Operating mode	M
Maximum light power (the luminaire can power the light source with a different power)	4.5 W
Active power	6.7 W
Insulation class	2
Luminous flux	555 lm
Battery	LiFePO4/C 6.4V 3.0Ah



PHOTOMETRY [m]

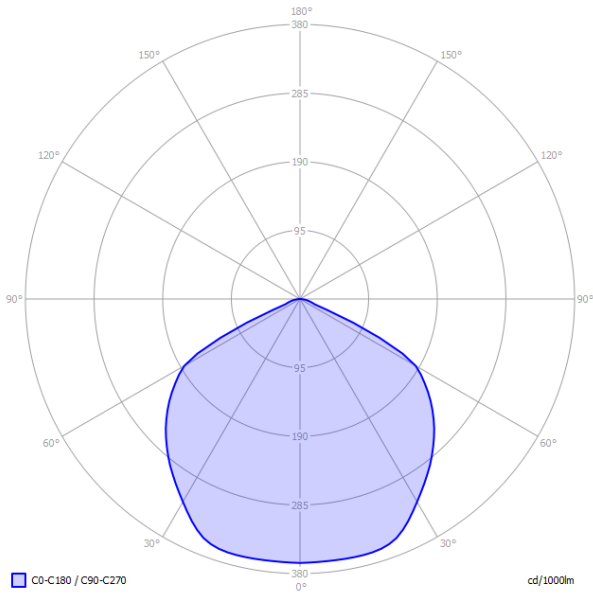

Ceiling height

2,5
3,0
4,0
5,0
6,0
7,0
8,0
9,0
10,0

Distance wall - fitting

4,2
4,7
5,7
6,4
6,6
7,0
7,0
7,0
6,9
6,9

Distance fitting - fitting

8,9
10,3
13,0
15,0
17,0
19,0
20,0
21,2
22,0

